

View from bottom
Ansicht von unten

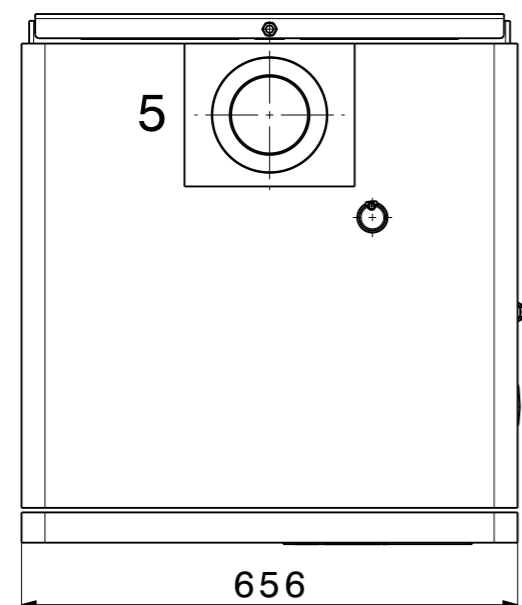
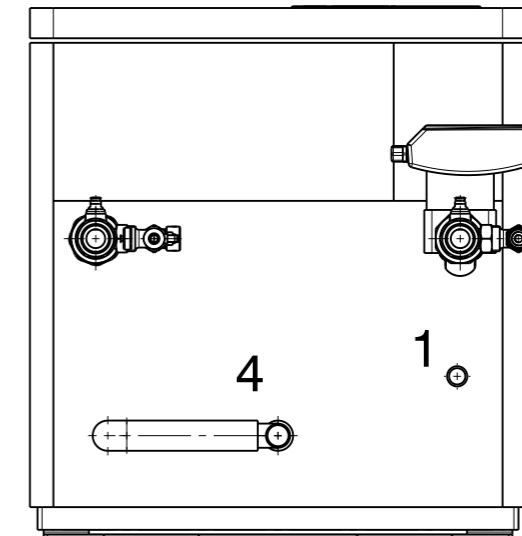

- 1 Gasanschluss R 3/4"
- 2 Vorlauf Heizung Rp 1 1/4"
- 3 Rücklauf Heizung Rp 1 1/4"
- 4 Kondensatablauf DN 40
- 5 LAS Abgas-Zuluftanschluss C 100/150
- 6 Abdeckung Kesselsteuerung
- 7 Sicherheitsventil
- 8 KFE Kugelhahn

- 1 Gas connection R 3/4"
- 2 Flow Rp 1 1/4"
- 3 Return Rp 1 1/4"
- 4 Condensat drain DN 40
- 5 LAS Flue Gas C 100/150
- 6 Cover control panel
- 7 Safety valve
- 8 Ball valve

Masstab 1:10

Hoval 42-TopGas (60,80)
4214814 Version 00
Stand 22.09.2015